

OUR MOST COMPACT HOME LIFT

Aritco HomeLift Compact
Product catalogue
2024



ARITCO™

Aritco aims to make home lifts a natural part of people's everyday lives.

We believe that the definition of a modern home will change – that modern homes and contemporary living will include home lifts. Our journey started 1995, with the simple idea of improving mobility everywhere. Today, Aritco lifts can be found in over 40,000 buildings and private homes around the world.

Simplicity, quality and innovation are the hallmarks of all Aritco's activities. We are constantly seeking new ways to improve the quality, design and user-friendliness of our products, as well as our environmental impact. Safety and reliability are top priorities, and we follow Europe's strictest quality and safety standards.

All Aritco lifts are developed and produced in Stockholm, Sweden, and we are proud to maintain the highest level of quality in all stages of the process, from design through to final installation in your home.

This catalogue is primarily made for all our partners around the world. The purpose is to show what Aritco can offer in terms of products, options and possible combinations.

Due to continuous product development, all specifications included in this catalogue are subject to change without prior notice. Reservations are made regarding misprints and articles being out of stock.

CONTENTS

Product summary	4
Lift sizes	6
Carrier	8
Lift color	10
Control panel	12
Floorings	14
Doors	16
Door control	18
Door machinery	20
Door options	21
Lift walls	22
Lift wall options	23
Communication, Drive system	24
SmartLift	25
Preparations before installation	26
European standards and safety	27
Recommended sales arguments	29
Drawings	30



PRODUCT SUMMARY

Aritco HomeLift Compact: Accessibility, Design & Space Efficiency

Great accessibility and design now come in smaller packages than ever before. With the Aritco HomeLift Compact, no house or space is too small for the convenience and safety that a home lift provides. Whether you are helping clients build a smart, new home from scratch or future-proofing an existing house, this elegant lift allows you to combine the benefits of being small with the possibilities of thinking big.

Type of lift:	Home lift intended for transportation of persons in buildings where the users are known.
Technical compliance:	European Machine directive 2006/42/EC European standard EN 81-41
Drive system:	Patented screw/nut system
Rated speed (max):	0,15 m/s
Travel height:	1 600 -15 000 mm
Number of stops:	Max. 6 stops per lift
Number of doors:	Max. 6 doors per lift
Number of doors per floor:	Max. 2 doors per floor
Pit:	50 mm (no pit is required when there is a threshold/ramp)
Top height:	Always 2 248 mm
Platform control:	"Hold to run", the destination button must be kept pressed down during the whole ride ¹⁾
Landing control (on door):	One-touch call
Environment:	Indoor
Emergency lowering:	Battery operated emergency lowering
Control voltage:	24 V
Motor:	2,2 kW
Power supply:	1-phase 230 V. Fuse 16A slow ²⁾
Rated load:	250 kg



- 1) For installations outside Europe one-touch operation is available
- 2) Frequency 50 or 60 Hz. Frequency Converter always included.

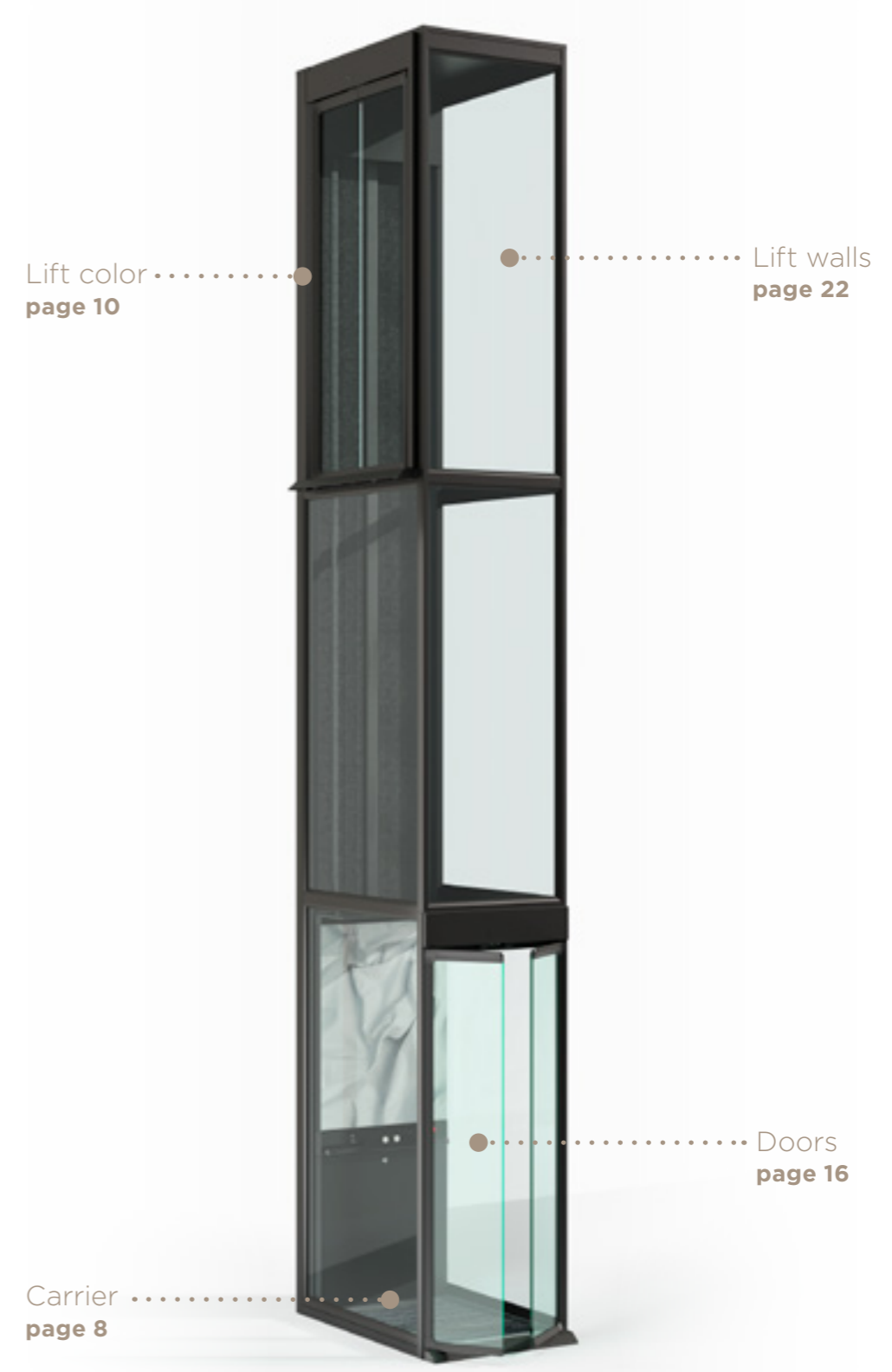

LIFT SIZE

580 x 805

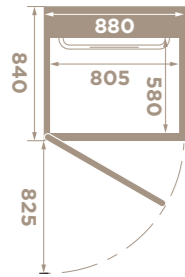
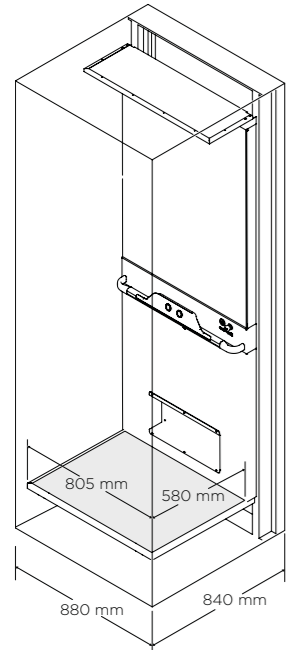

Carrier size: 580 x 805 mm
External dim.: 840 x 880 mm
Rated load: 250 kg / 2 persons

880 x 805

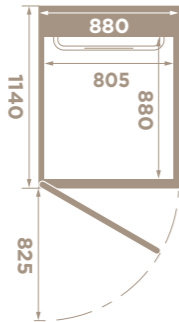
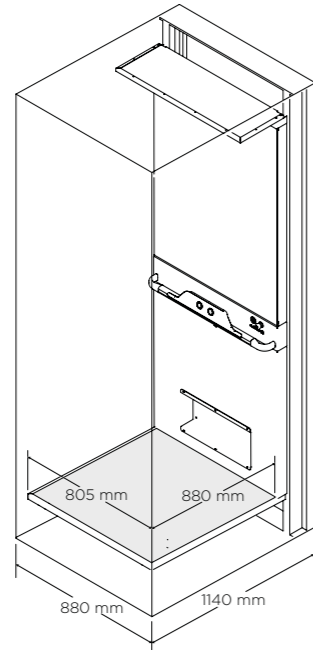

Carrier size: 880 x 805 mm
External dim.: 1140 x 880 mm
Rated load: 250 kg / 2 persons

1080 x 805

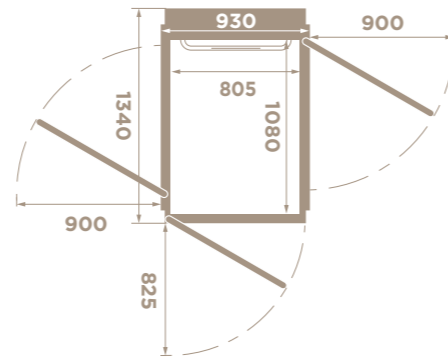
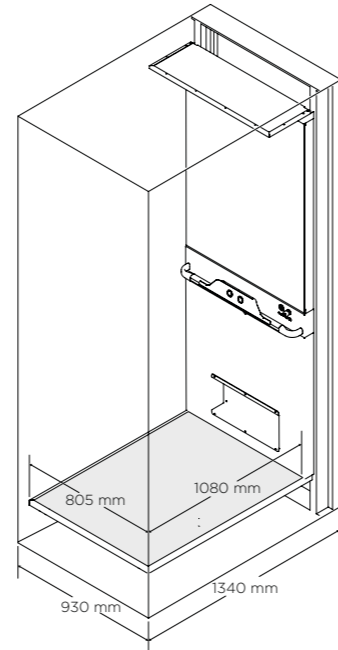

Carrier size: 1080 x 805 mm
External dim.: 1340 x 930 mm
Rated load: 250 kg / 2 persons

(mm)

Aritco HomeLift Compact is available in 3 different platform sizes. The rated load is 250 kg and the power supply needed is 230 V 1-phase.

Carrier size: Inner dimensions of the lift
External dimensions: Outer dimensions of the lift (shaft size)
 For detailed drawings see page 30.



CARRIER

The platform is in its basic execution delivered with a side wall (full height) including the control panel.

The full height wall comes with a LED light cap, a mirror and a control panel with integrated handrail.

The platform wall is as standard painted in one of the three colors; Traffic White (RAL9016), Jet Black (RAL9005) or Anthracite Grey (RAL 7016), but can be painted in another RAL color as option (see page 10-11 for available options and details about the colors).

The control panel with integrated handrail and the plate behind are painted in Traffic White (RAL9016), Jet Black (RAL9005) or Grey anodic color Natura.

The LED light cap placed above the mirror or DesignWall is providing lighting for the floor of the platform and the control panel (50 LUX) and there will be no additional light in the mirror or DesignWall.

MIRROR

Mirror 800 x 1128 mm is included as standard.

FOOT BOX

As an option the panel under the control panel can be ordered with a footbox. i.e. with a niche that adds extra space for the feet in the bottom of the platform panel (for wheelchair users). Size of the niche: depth 80 mm, height 194 mm, length 456 mm.



DESIGNWALL

The full height wall can also be delivered with a DesignWall instead of a mirror. It's a design feature which gives the customer an opportunity to personalize the lift with an artworks, creating a piece of art in his/her home. The DesignWall is available with eight different artworks, created by Scandinavian designers and artists. The artwork is placed behind a glass panel.

PLATFORM WALL IN STANDARD COLORS:



Platform wall and control panel with integrated handrail in Traffic White (RAL 9016)



Platform wall and control panel with integrated handrail in Jet Black (RAL 9005)



Platform wall in Anthracite Grey (RAL 7016) and control panel with integrated handrail in Grey anodic color Natura.



Diagonal by Alexander Lervik



Orientalic by Alexander Lervik



Key West by Erik Undéhn



Skyline by Erik Undéhn



Sheets by Rikard Lilja



Structure by Rikard Lilja



Pink by Lotta Ingman



Orange by Lotta Ingman



Geometric Blue by Evelina Kroon

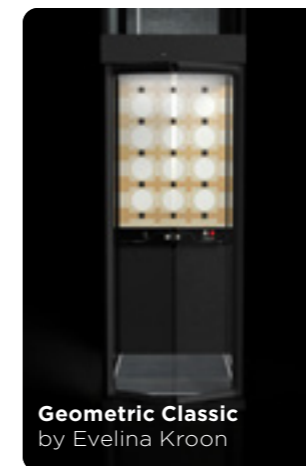

Geometric Classic by Evelina Kroon



Geometric Pink by Evelina Kroon



Mirror

LIFT COLOR

Aritco HomeLift Compact can be painted in any RAL color from the Chart K7 classic chart (except for pearl and fluoridating colors*).

The Aritco HomeLift Compact is as standard painted in Traffic White (RAL9016), Jet Black (RAL9005) or Anthracite Grey (RAL7016). There will be no additional price or lead time for lifts painted in these standard colors. For other colors there will be additional price and lead time. For a set of common colors, see page 11, we offer

shorter lead time and lower price than the rest of the colors from the RAL chart K7 classic which have longer lead time and higher price.

The paint is a soft-textured powder coat with a matt surface (gloss level 12).

Door handles and the control panel with integrated handrail are painted in colors that shall protect them from wear and tear. Traffic White (RAL9016) with gloss level 70 and without structure and Jet Black (RAL9005) with a matt surface and without texture. The grey color that looks like Aluminum and is the anodic color Natura with gloss level 20 and without texture.



Standard finish:
Jet Black (RAL9005)

Standard finish:
Traffic White (RAL9016)

Standard finish:
Anthracite Grey (RAL7016)

Complete lift in other finish:
Brown Red (RAL3011)

Complete lift in standard finish :

The complete lift painted in standard color Traffic White (RAL9016), Jet Black (RAL9005) or Anthracite Grey (RAL7016) including shaft, doors and platform.

- Shaft and door glass profiles in Aluminum, but can be painted in same color as shaft resp. doors
- Control panel with integrated handrail and door handles are painted in Traffic White (RAL9016), Jet Black (RAL9005) or Grey anodic Natura color.

Complete lift in other finish :

The complete lift painted in optional color, including shaft, doors and platform.

- Shaft and door glass profiles in Aluminum, but can be painted in same color as shaft resp. door blades
- Control panel with integrated handrail and door handles are as standard painted in Grey anodic Natura color, but can as option be painted in Traffic White (RAL9016) or Jet Black (RAL9005).

Partial lift in other finish :

Possible to paint the shaft, the doors and platform in different colors.

- Lift walls/shaft in one color.
- All doors in one color.
- Platform wall in one color.
- Control panel with integrated handrail in Traffic White (RAL9016), Jet Black (RAL9005) or Grey anodic Natura color.
- Door handles in Traffic White (RAL9016), Jet Black (RAL9005) or Grey anodic Natura color.
- Shaft glass profiles in Aluminum or in same color as the shaft
- Door glass profiles in Aluminum or in same color as the doors.

Standard colors

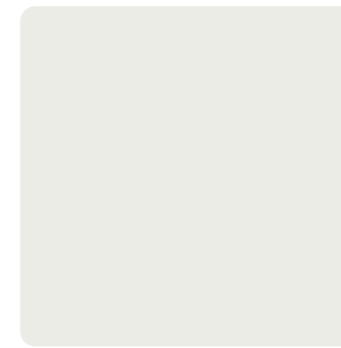

Traffic White
RAL 9016



Anthracite Grey
RAL 7016



Jet Black
RAL 9005

Common colors



White Aluminum
RAL 9006



Telegrey 1
RAL 7045



Moss Green
RAL 6005



Brown Red
RAL 3011

Note that the actual color of the lift may differ from the color samples pictured above.

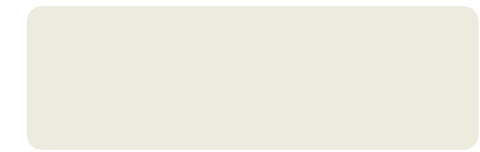

Grey White
RAL 9002

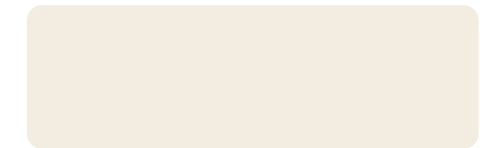

Pure White
RAL 9010

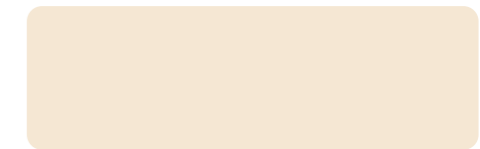

Oyster White
RAL 1013



Light Ivory
RAL 1015

Grey Anodic Natura color

Option for control panel with integrated handrail and door handle color.



*Any RAL color means in this case any RAL color from the 213 color RAL chart K7 classic except the following colors that are not available; Fluoridating colors: RAL 1026, 2005, 2007, 3024, 3026, 6038 Pearl Colors: RAL 1035, 1036, 2013, 3032, 3033, 4011, 4012, 5025, 5026, 6035, 6036, 7048, 8029, 9022, 9023

CONTROL PANEL

CONTROL PANEL FRONT PART AND BACK PART

The control panel is built up of two parts, the front part with the control panel with integrated handrail where the destination buttons are located and the back part with alarm button, emergency stop, max weight and number of persons and if ordered autodialer and key lock.

The control panel with integrated handrail is painted in colors that shall protect them from wear and tear. Traffic White (RAL9016) with gloss level 70 and without structure and Jet Black (RAL9005) with a matt surface and without texture. The grey color that looks like Aluminum and is the anodic color Natura with gloss level 20 and without texture.

AUTODIALER

Option for emergency calls. See page 24 for options for two-way communication.

DESTINATION BUTTONS

Destination buttons for Aritco HomeLift Compact are with 32 mm round buttons with text/numbers. The touch plate of the button is neutral/flat and in matt stainless steel. The text/number is pierced opal (white translucent injected). Height of characters 10 mm.

Following buttons are available:

-2, -1, 0, 1, 2, 3, 4, 5, 6, 0A, 0B, 1A, 1B, 2A, 2B, 3A, 3B, BG, E, G, K, U, B



KEY SWITCH ON PLATFORM

Key switch placed on control panel back part. The key switch locks the platform functions and prohibits unauthorized use. The key switch is serial connected to all destination buttons and one key switch per lift can be ordered as an option. The brand of the key switch is Telemecanique.

EXTERNAL ALARM SOUNDER

External alarm sounder mounted outside the lift. It is connected to the alarm button and when the alarm button is pressed the external alarm sounder will give a loud signal outside the lift to attract attention in case of emergency. Can be ordered as an option.

EMERGENCY STOP BUTTON

Button in "mushroom" type for emergency situations. Included as standard.

For installations outside Europa a red emergency stop button is delivered instead of the "mushroom" type.



ALARM BUTTON

A standard alarm button is always delivered with the lift. When it is pressed a buzzer sounds. This is only a signal to the user that the button is pressed. The alarm button may be connected to an external alarm sounder or an autodialer.

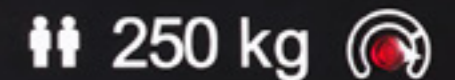
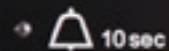

FLOORINGS

Choose between the following vinyl options. It is also possible to order the lift without a floor, which enables the homeowner to choose and fit their own floor. The maximum thickness of an externally selected floor is 3 mm.

Choose between the following vinyl options.

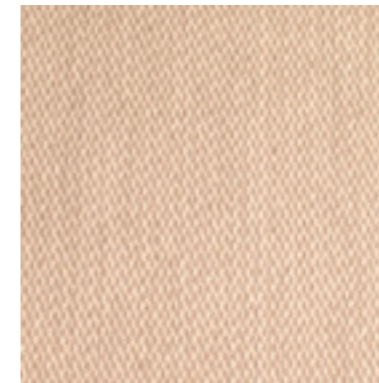

Bolon Sisal Plain Sand
Option

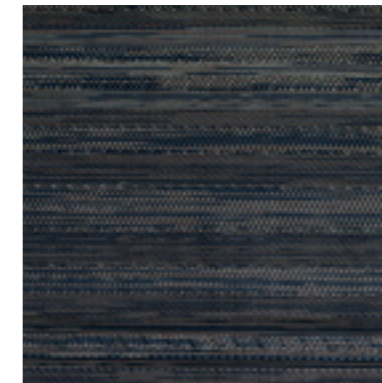

Bolon Graphic Gradient
Option



Bolon Flow Stream
Option

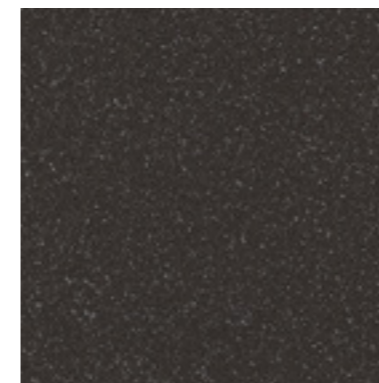

Dark Grey Vinyl
Standard

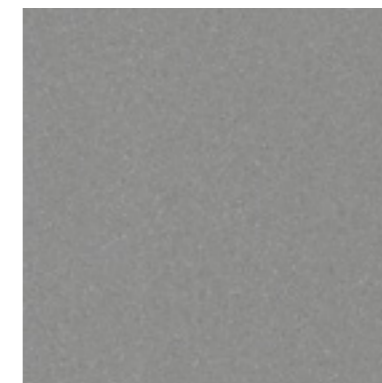

Light Grey Vinyl
Standard

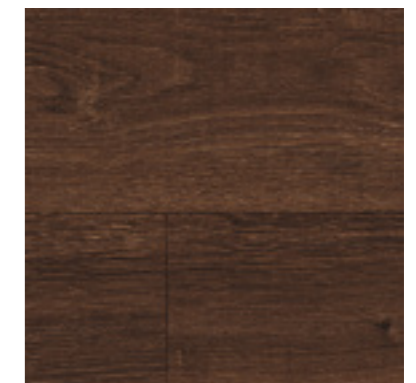

Aged Oak Vinyl
Standard

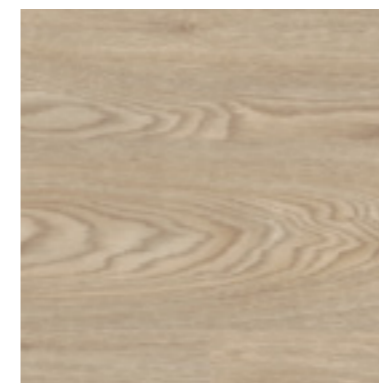

Oiled Oak Vinyl
Standard

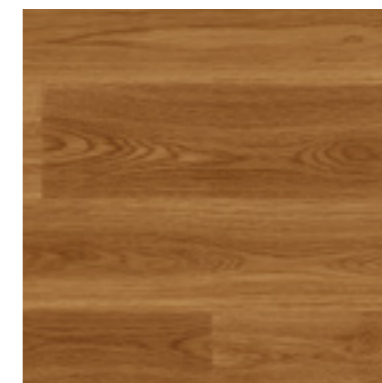

European Oak Vinyl
Standard



DOORS

The landing doors that are installed at each landing are of two different types, large glass doors which is a swing door with one door blade and the double door with two door blades with central opening.



Large glass door



Double door

LARGE GLASS DOOR

The large glass door is a swing door with one door blade with a glass window.

DOOR HINGE:

All doors can be left- or right hinged.

OPENING WIDTHS:

800, 900 mm

OPENING HEIGHTS:

1800, 1900, 2000 mm

The actual height of the door is 40 mm higher since a plate that covers the joint between the door and the frame is mounted on the door.

DOOR BLADE AND FRAME:

Door on A/C-side is made of galvanized steel and the door on B-side of cold drawn steel.

GLASS WINDOW (VISION)

Laminated and toughened glass, 8 mm thick. A glassed area according to EN81-41 is standard for all doors. Standard is with clear glass optional is to have tinted glass.

Glass window vision size B-side door: 612x1472 mm (800 x 2000 mm door)

Glass window vision size A/C-side door: 712x1472 mm (900 x 2000 mm door)

DOOR GLASS PROFILES:

The glass windows are fitted in Aluminum door glass profiles. Unpainted anodized Aluminum is standard and as option it's possible to order the door glass profiles in the same color as the door.

COLOR:

All doors for a lift (including door blades and frames) are always painted in the same color. For color options see page 10-11.

Door opening width	Door opening height	Available for B-side	Available for A/C-side
800	1800 ¹⁾	805	-
	1900 ¹⁾		
	2000		
900	1800 ¹⁾	-	1080
	1900 ¹⁾		
	2000		

(mm)

¹⁾ Not available on top floor since top height of shaft is always 2248 mm



Clear glass

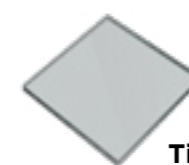

Tinted glass

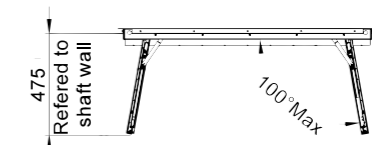

A and C-side

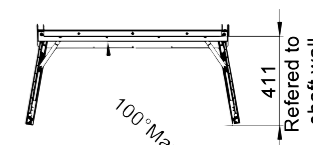

B-side

DOUBLE DOOR

Double door with two door blades with central opening. The door blades are made of glass with painted profiles. The door is always delivered with two internal door openers which opens the doors automatically. If the space in front of the door is limited it is a good solution to use the double door.

OPENING WIDTHS:

780, 900 mm

OPENING HEIGHTS:

2000 mm

The actual height of the door is 40 mm higher since a plate that covers the joint between the door and the frame is mounted on the door.

DOOR BLADE AND FRAME:

Painted Aluminum profiles and Zinc details.

GLASS DOOR BLADES

Door blades are made of toughened and laminated glass, 14 mm thick. Clear glass is supplied as standard, while tinted glass can be ordered as an option.

COLOR:

All doors for a lift (including door blades and frames) are always painted in the same color. For color options see page 10-11.

Door opening width	Door opening height	Available for B-side	Available for A/C-side
780	2000	805	-
900	2000	-	1080

(mm)

DOOR FRAME

On the A and C side the large glass door and double door are always delivered with a frame. The height of the frame depends on the door opening height and is always 240 mm higher than the door opening height.

Frame width on A/C-side 1160 mm.

Door opening height	Frame height
1800	2040
1900	2140
2000	2240

(mm)

DOOR CONTROL

The door control is either placed on the door frame of each landing door and/or placed away from the lift as an external control.

DOOR CONTROL ON DOOR FRAME

For Aritco HomeLift Compact it is only place for a door faceplate on the door frame when having a large glass door on A or C side.

CALL BUTTON IN A PLASTIC BOX

Aritco HomeLift Compact does not have a door frame on the B-side of the lift and therefore there is no place for a door faceplate on the lift. Standard solution for the B-side or when having a double door on the A/C-side is to have the call button in a plastic box connected to the lift via a cable. The plastic box can be delivered in white, grey or black.

CALL BUTTON

The call button comes with a background lit frame which indicates the status of the lift.

- Green light indicates that the lift is at your floor. Lit only on the floor where the platform is at the moment.
- Red light indicates that the lift is occupied. It is busy and you can't call for it.
- The flashing light indicates that the safety circuit is broken, e.g. that the emergency button is pressed, the door is open on another floor for more than one minute, the door is blocked or the safety frame is pressed down. The flashing light can also be activated by a sum alarm, more information is then available in the service memory.

The same type of call button is used when the door control is placed on the door frame, externally or as a radio controlled call button.



DOOR FACEPLATE

The door faceplate can be placed directly on the door frame or externally in an external call station box. The door faceplate is painted in the same color as the door frame.

The door faceplate can hold:

- Call button
- Key switch Telemecanique / School locking
- Key switch prepared for Assa / School locking
- Key switch prepared for EUR / School locking



COVER PLATE

If the door control is placed externally and not on the door frame a cover plate that covers the hole in the door frame is delivered with the lift. The cover plate is always delivered with the lift in the same color as the door frame.

KEY SWITCH / SCHOOL LOCKING

Instead of having a standard call button on the door faceplate you can have a key switch. You then need to have the key to be able to call for the lift and to access the lift. Includes school locking function which automatically locks the door 10 seconds after it is closed. Aritco can provide one key switch per door.

Three brands to choose from:

- ASSA (Nordic markets only). Aritco only delivers the housing, Aritco does not deliver the locking cylinder.
- EUR, Aritco only delivers the housing. Aritco does not deliver the locking cylinder.
- Telemecanique



EXTERNAL DOOR CONTROL - PLACED AWAY FROM LIFT

Door control placed away from the lift in an external call station box connected to the lift via a cable or as a radio controlled call button without any cable. Standard solution for the B-side or when having a double door on the A/C-side is to have the call button in a plastic box connected to the lift via a cable. It is also possible to have an external call station box. Both connected to the lift with a cable.

RADIO CONTROLLED CALL BUTTON

The radio controlled button, placed in a white, grey or black plastic box, gives the customer the freedom to place the call button wherever they would like within 10 meters from the lift. The radio controlled call button runs on batteries and provides remote controlled access to the lift. The radio controlled call button doesn't indicate the status of the lift.

Can be ordered as an option.



EXTERNAL CALL STATION BOX

The door faceplate can be placed away from the lift and will then be placed in an external call station box. For a lift with the shaft painted in Traffic White (RAL9016), Jet Black (RAL9005) or Anthracite Grey (RAL7016) the box is painted in the same color. For all other shaft colors, the box is painted in Anthracite Grey (RAL7016). The box can either be mounted exterior on a wall (wall mount) or in the wall so that you only see the door faceplate (flush mount). The external call station box can be ordered as an option. The standard length of the cable delivered with the external call station box is 1.5 m, as an option it can be 10 m long.

Size flush mount: 82x150x50 mm

Size wall mount: 95x185x50 mm



DOOR MACHINERY

The landing doors are always delivered with either a door opener or a door closer. They are mounted internally (in the door frame so that you can't see it from the outside).

All openers and closers are available for both left and right hinged doors.

When having two doors on the same landing, both doors will be opened at the same time when having door openers.

Door type	Internal door closer	Internal door opener
Large glass door standard	•	•
Double door		•

INTERNAL DOOR OPENER

Opens and closes the door automatically. It is built into the door frame and can't be seen from the outside. Can be ordered as option. Standard for double doors.

INTERNAL DOOR CLOSER

Closes the door mechanically (door is opened manually). It is built into the door frame and is invisible from the outside. Includes function to keep door open until the user manually closes the door. Standard for large glass doors.

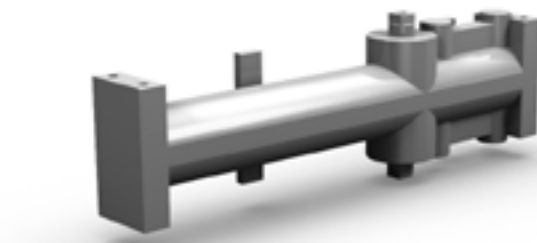

DOOR OPTIONS

LANDING INDICATOR ON DOOR

Digital display positioned at the door frame. It shows which floor the lift is on at the moment. The landing indicator can also show following system information:

- Warning if the lift batteries are low.
- A bell when the alarm button has been pressed.
- Number of starts and total run time since installation or since last reset.
- A weight symbol will appear if the lift is overloaded.
- If connected to the buildings fire alarm a "Fire" symbol will be shown when alarm is activated.



THRESHOLD AND RAMP

The lift can be installed 50 mm below the floor level in a so-called recessed installation with a pit. This enables the lift carrier floor to be flush with the floor of the house on the bottom landing. If it is not possible to make a 50 mm pit in the floor, the lift can be installed directly on the floor. When the lift is installed directly on the floor, the lift carrier floor will be 50 mm higher than the floor of the house. For lifts installed directly on the floor the lift can be ordered with a high threshold (50 mm) with or without a removable ramp or with a fixed ramp.

Thresholds and ramps are painted in same color as the door,

- Pit with threshold (1)
- Installed directly on floor with high threshold and without ramp (2)
- Installed directly on floor with high threshold and removable ramp (2) + (3)
- Installed directly on floor with fixed ramp (4)

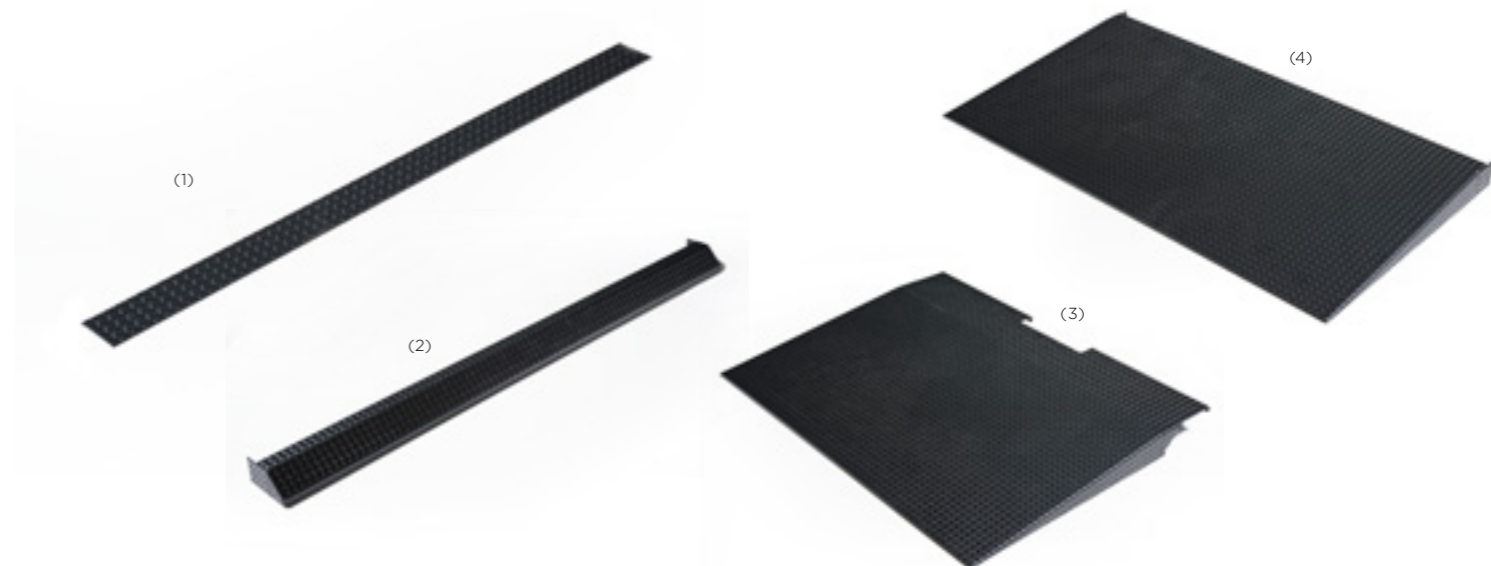

Anodic Natura
(Aluminum look)

Traffic White
(RAL 9016)

Jet Black
(RAL 9005)

DOOR HANDLE

Door handles casted in zinc standard painted in Traffic White (RAL9016) and can be painted in grey, anodic color Natura, that looks like Aluminum or Jet Black (RAL9005). Door handles are painted in colors that shall protect them from wear and tear. See details on page 10 and 11.

LIFT WALLS

The lift is always delivered with a self supporting shaft.

The top height of the shaft (distance from top floor to top of shaft) is always 2 248 mm. If the lift isn't installed against a wall, machine side back cladding can be added on the outside of the lift on the machine side. For all sides except for machine side you can choose to have shaft panels in steel or glass. The mast of the Aritco HomeLift Compact is always delivered in parts.

INNER CEILING

Aritco HomeLift Compact always comes with an inner ceiling, painted in the same color as the shaft walls.

SHAFT PANELS

Standard is 25 mm thick shaft panels with EPS (polystyrene) core and steel plates. As an option the shaft panels can be ordered with a core of rockwool instead of EPS.

GLASS

As an option shaft glass panels can be ordered. The shaft glass panels are made of laminated and toughened glass and are as standard in clear glass and as option in tinted glass. See page 17 for pictures. Note that when choosing clear glass the drive screw and flat cable will be seen from outside the lift. The glass panels are 8 or 10 mm thick depending on the size of the glass. Glasses which are higher than 1000 mm are always 10 mm. The glasses are fitted in Aluminium profiles. These profiles are in Aluminium as standard, but can be painted in any of the specified RAL colors on page 10-11.

Shaft panels / glass with Aluminium profile:

Height (mm)	Clear glass	Tinted glass
736	•	•
1472	•	•
2208	•	•
Customized ¹⁾	•	•

¹⁾ Additional cost per mm. Maximum height per glass panel is 2200 mm

MACHINE SIDE BACK CLADDING

The machine side back cladding in steel covers the backside of the machine side if the lift is not mounted against a wall. The machine side back cladding can be ordered as an option and can run from bottom to top height. It can also be ordered partly if the lift is partly mounted to a wall. The machine side back cladding is painted in same color as the shaft and covered with black thin mats to give the lift a more esthetical look from inside the shaft.

CABLE DUCTS

When installing the doors on the B-side, cable ducts are installed on the A-side or C-side. The cable duct is used to run cables from the doors on the B-side to the mast. There are two different types of cable ducts, one when having shaft panels and one when having shaft glass panels. The cable ducts are esthetically concealed in the design.

LIFT WALL OPTIONS

DESIGNPANELS

To give the lift an even more esthetical appearance DesignPanels can be ordered as an option. The DesignPanels are installed inside the lift on the mast side, and covers parts of the mast. The front of the DesignPanels is made of grey compressed PET fibre and the back side in Ecophon Fiberspring®. This combination of materials improves the lift's acoustic profile and even give a more esthetical appearance. The materials in the design panels are 100% recyclable. The DesignPanels can be ordered for lifts with or without machine side back cladding.



DesignPanels

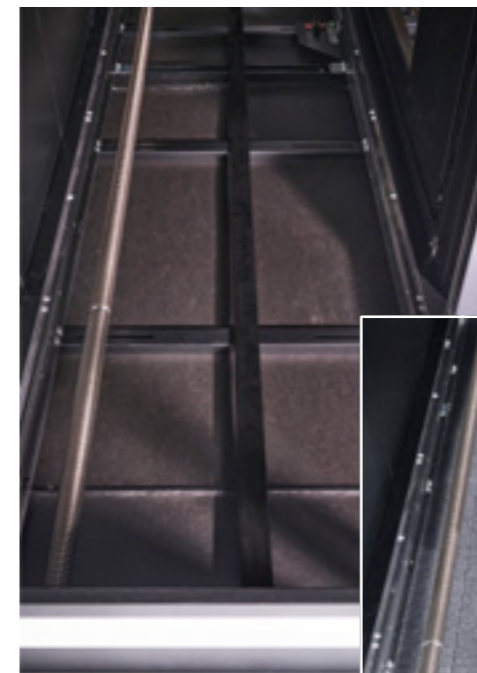

Machine side back cladding with thin black mats



EXTERNAL SERVICE PANEL

A service panel is always placed in the electrical cabinet. It is used to run tests etc., and for emergency running the lift. The electrical cabinet and the standard service panel is mounted in the top part of the shaft and can't be reached from outside. Therefore it is connected to an external service panel (wall mount) which is mounted in a faceplate box. For lifts with the shaft painted in one of the standard colors, the box is painted in the same color. For lifts with the shaft painted in another color the box is painted in Anthracite Grey (RAL7016). The faceplate is in Grey anodic color Natura. The external service panel must be activated with a 3 edge key before it can be used. Size: 95 x 185 mm



SHAFT SUPPORT FRAME

Used as an alternative fixing method when the mast is not mounted against a wall. One support frame for each floor is needed, except for bottom floor. The support frame is painted in the same color as the shaft. The support frame consists of four jointed parts, designed for the 1080 mm platform. However, two of the beams are prepared with small drilled holes so they can be cut to fit the other, smaller platform sizes.

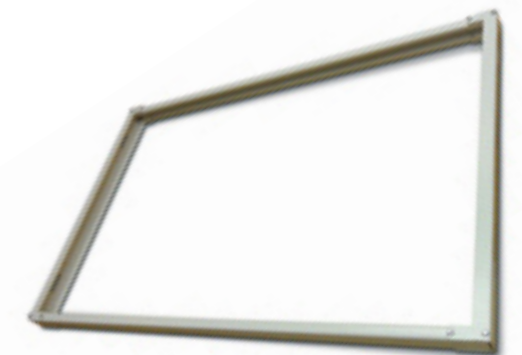

EXTRA ANTI-RUST PROTECTION

To protect the lift when exposed to humid environments during transport or installation, the lift can be ordered with guides rails in corrosion class C5 as an option. Recommended for sea transport.

COMMUNICATION

Two way communication is mandatory according to EN81-41. Choose from one of the following options or install your own phone.

AUTODIALER

Equipment for emergency calls. Integrated on the destination panel. Dials automatically when the alarm button is pressed. When unanswered after a predefined time, the call is automatically forwarded to the next number.

The autodialer can be equipped with a GSM module. Aritco does not supply SIM card.

PHONE

The telephone works as a standard telephone but is intended for emergency calls. The phone is mounted on the platform panel. Equipped with redial memory, mute button and a lamp indicator for on/off. Can be equipped with a GSM module. Aritco does not supply SIM card.

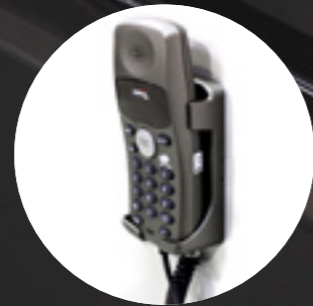

SmartLift

Aritco HomeLift Compact is connected and comes with a gateway. Via the SmartLift App the user can get valuable information about the status of the lift and when the lift needs service. The App in combination with a service contract and SmartLift Fleet will improve the service and attention that you as a partner can offer to your customers, as well as making your life easier.

The SmartLift App and SmartLift Fleet will continuously be updated with new features and functionality.

Aritco SmartLift APP

Via the SmartLift App the user gets valuable information about his/her lift and can make personal settings.

- Safety status
- Service indicator
- Lift usage statistics
- Lift information
- Child Lock (Beta)
- Floor Lock (Beta)

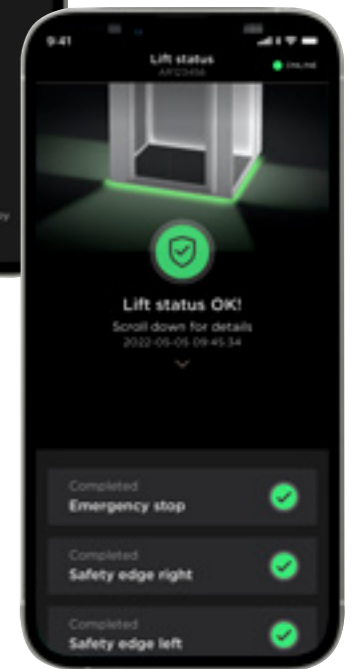
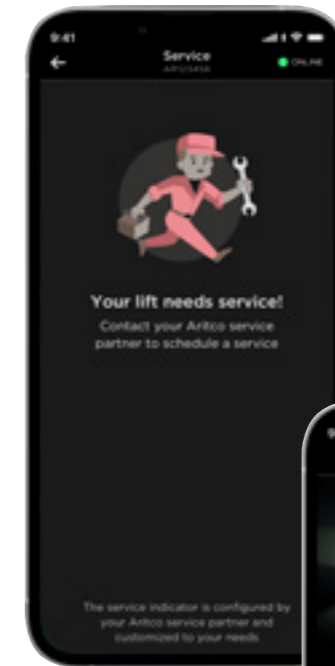

DRIVE SYSTEM

POWER SUPPLY

For Aritco HomeLift Compact the following is valid:

1-phase 230 V. Fuse 16A slow

- Frequency converter with built in soft start and stop
- Frequency 50 or 60 Hz

MAIN ELECTRICAL SUPPLY

Provide main electrical supply to the lift electrical cabinet in the pit via a main breaker outside the lift. The main electrical supply inlet is located in the top of the lift. The lift must be connected to the building main earthing terminal via a PE conductor.

LUBRICATION

The screw must be lubricated at regular intervals. **Automatic Lubrication:** Pump based system that provides a constant oil flow on the drive screw. Standard for Aritco HomeLift Compact.

BATTERY GUARD

The battery guard ensures that the batteries are not damaged and that the lift has enough power so you can run the lift in the case when the power to the lift is cut. It ensures that the lift is turned off (all power consumers are turned off) when the power of the batteries reaches 22 V. This means that when you go on vacation you don't need to turn off the lift even if you turn off the power in the house, the battery saver will ensure that the batteries are not deeply discharged. The battery guard function is included on the main control board.

BATTERY OPERATED EMERGENCY LOWERING

All Aritco lifts have battery operated emergency lowering as standard. You can lower yourself from inside the lift and get out by yourself when there is a power failure. Possible to run the lift to nearest level from the platform (possible to go down) - Executed when pressing a destination button. Can also be run externally from the call button (hold to run) or service box.

Aritco SmartLift Fleet

Via SmartLift Fleet you as a partner can monitor the lifts from a distance and via a dashboard get valuable information and see status of your lifts.

- Alarm notifications of active alarms
- Alarm logs
- Status of connectivity, which lifts are on-line and which are off-line
- Number of starts
- Runtime
- Number of starts or time to next service

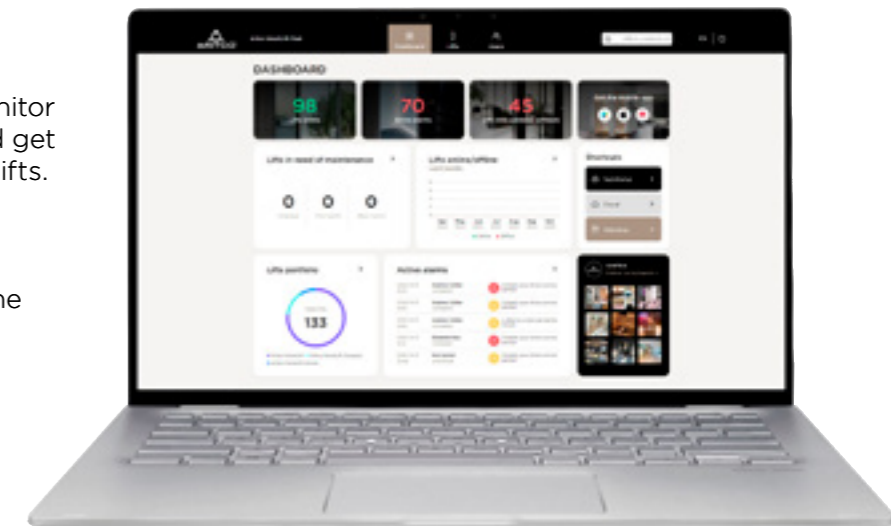

RECOMMENDED SALES ARGUMENTS

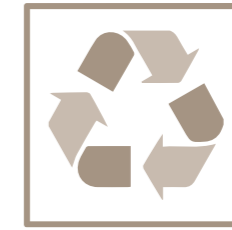
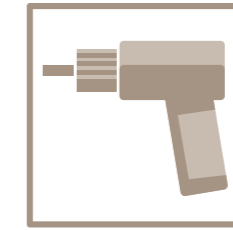

ARITCO HOMELIFT COMPACT: ACCESSIBILITY, DESIGN & SPACE EFFICIENCY

Great accessibility and design now come in smaller packages than ever before. With the Aritco HomeLift Compact, no house or space is too small for the convenience and safety that a home lift provides. Whether you are helping clients build a smart, new home from scratch or future-proofing an existing house, this elegant lift allows you to combine the benefits of being small with the possibilities of thinking big.

GREAT DESIGN

Aritco unique Scandinavian design; with a sleek platform design with DesignWall and control panel with integrated handrail. Double doors and contemporary and flexible shaft glass solutions as well as DesignPanels that adds to the aesthetical appearance and sound profile of the lift.

CUSTOMIZATION POSSIBILITIES

Several customization possibilities. You can choose from more than 200 different colours, 2 different glass types, 8 different floorings and a DesignWall (backwall) with 11 different artwork.

EASY INSTALLATION

Means that the lift is both easy and fast to install. A normal installation only takes two days.

MINIMUM BUILDERS WORK AND SMALL FOOT-PRINT

The lift can be installed without a pit, with a ramp (or with a 50 mm pit without ramp). All parts are included in the shaft - no extra machine room or head room needed.

WARRANTY

5 year product warranty and 10 year drive technology warranty. For details see aritco.com.

RECYCLABLE

More than 95% of the parts are recyclable.

LOW OPERATION AND MAINTENANCE COST

Screw and nut drive system with very low operating and maintenance costs.

NO HYDRAULICS, WHICH MEAN NO LEAKAGE OR SMELL

No additional space needed for hydraulic unit.

ROBUST SHAFT

25 mm shaft panels. Robust and resistant to damage. Good noise and acoustical isolation.

SMARTSAFETY SYSTEM

The lift is also equipped with our SmartSafety system, with safety features, to meet all situations that can occur in a home, to prevent accidents.

- **The lift can't fall down.** The self locking concept, i.e the friction between drive screw and nut will prevent the lift from falling down. No additional brake system is needed.
- **You can always get out of the lift by yourself.** If there is a power failure, you can always get out of the lift by yourself with battery operated emergency lowering. Use the platform buttons and the lift will take you to the closest lower floor and you can open the door and get out by yourself.
- **You can always contact someone outside the lift.** The lift is equipped with a phone for emergency calls.
- **Lift stops automatically.** Safety edges around platform and platform wall will prevent something to get trapped between the moving platform and the shaft/walls. It's also possible to stop the lift by using the emergency stop button.

SmartLift

The lift is SmartLift enabled which means you also get live status information in the app and the maintenance provider can get access to a Fleet management system for remote monitoring and support of the lift.



DRAWINGS

See site preparation manual for exact details regarding installation.

Platform 1080 × 805

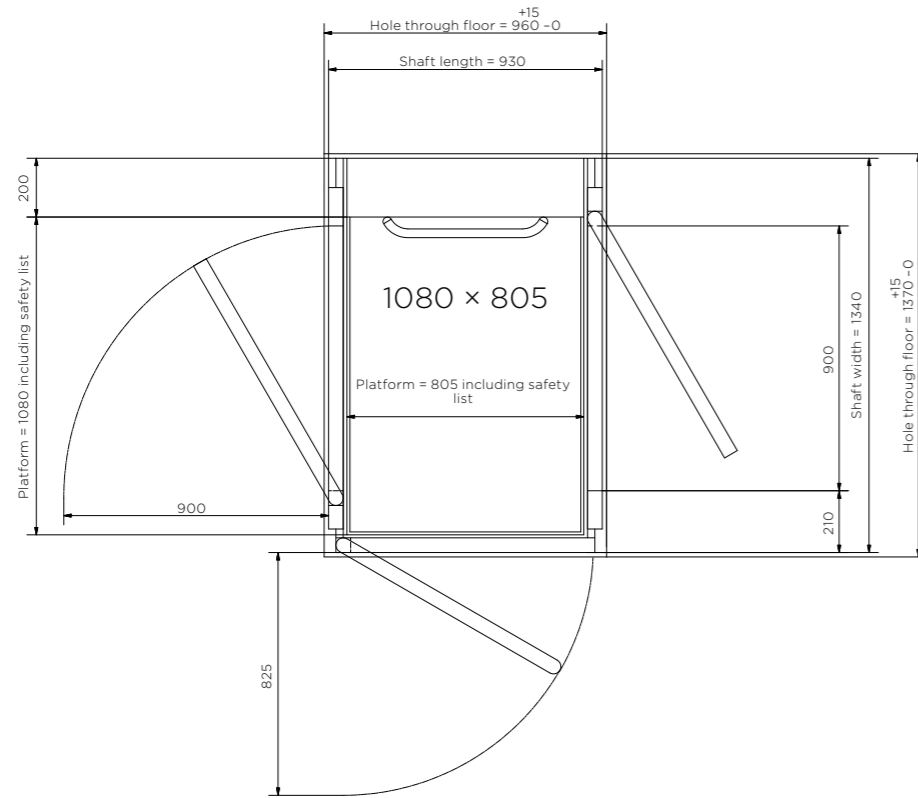

Platform 880 × 805

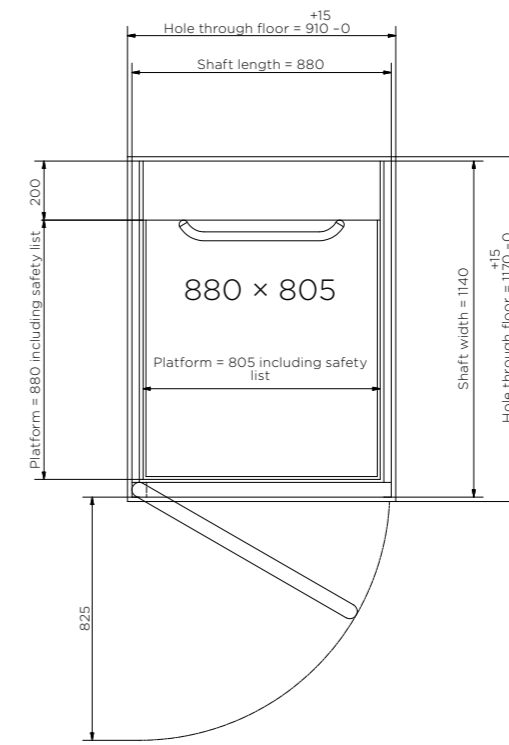

Platform 580 × 805

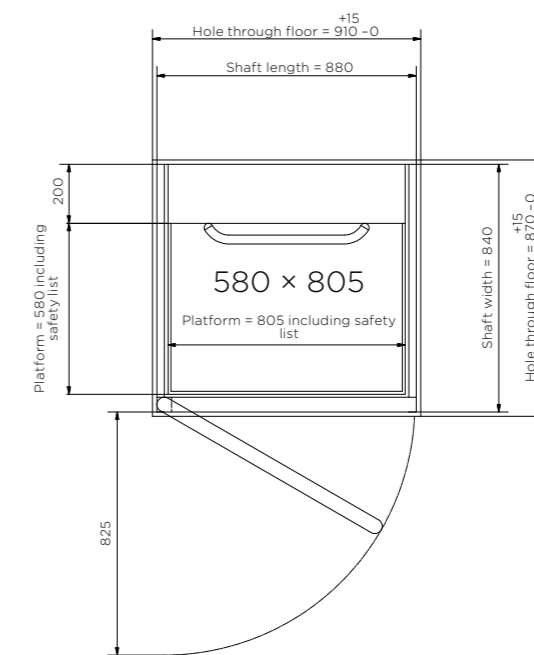

[mm]

[mm]

Aritco is a worldleading manufacturer
of platform lifts and home lifts. Read
more at **aritco.com**

Follow Us!

